



ARCHITECTURAL
GRATES + DRAINS

2015⁺

Product Guide



2015⁺

Stormtech Product Guide

Contents

Product Selection Process	PAGE 1	Flow Rate + Hydraulic Guide	PAGE 52
Product Selector	PAGE 2-3	Maintenance + Care	PAGE 53

Products

100 Range	PAGE 4-16	Vinyl Clamp Range	PAGE 47
65 Range	PAGE 17-40	Special Assembly Range	PAGE 48-49
38 Range	PAGE 41-43	Slot Drain Range	PAGE 50
Square Range	PAGE 44	Custom Fabrication	PAGE 51
Threshold Range	PAGE 45-46		



Stormtech has achieved Watermark Certification across our complete product range.

Product Selection Process

Choosing your Stormtech Drainage Product

1

Product Range

Select a product range based on Stormtech standard width stainless steel grates or your custom width (see available specifications).

38

65

100

CUSTOM

2

Grate Style

Choose a Stormtech designer grate finish or Tile Insert for your linear drainage style.

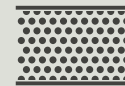
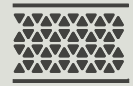

3

Channel Material

Drainage channels and fittings are available in either uPVC or highly durable Stainless Steel.

uPVC

316
GRADE

4

Channel Depth

Choose from Stormtech's available standard channel depths (see Product Selector for Range/Depth combinations).

SEE SPECIFICATIONS FOR CUSTOM DEPTH.

21-25mm

26-35mm

40-45mm

CUSTOM

5

Drain Length

Complete Kit
Lengths up to 6000mm
(see chosen product for available lengths)

Made-to-Length
Specific length with custom outlet position
for standard size products.

Custom Made
For non-standard width/depth requirements.

Kit

Made to
Length

CUSTOM

Product Selector

Find the right Stormtech product.
Match your preferred Grate + Range + Drain Depth + Kit Type.

Drain Depth COLOUR GUIDE

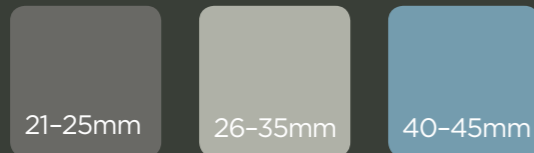

AR Architectural

RANGE - WIDTH -	MODULAR KITS		MADE TO LENGTH - CUSTOM OUTLET -	FIXED-LENGTH - CENTRE OUTLET -
	uPVC Channel	Stainless Steel Channel	All Stainless Steel	All Stainless Steel
38mm	38ARG40 PAGE 41		38ARi40MTL PAGE 41	
65mm	65ARG25 PAGE 18	65ARi25 PAGE 18	65ARi25MTL PAGE 17	65ARiCO25 PAGE 17
	65ARG40 PAGE 20	65ARi40 PAGE 19	65ARi40MTL PAGE 19	
100mm	100ARG20 PAGE 5	100ARi20 PAGE 5	100ARi20MTL PAGE 4	100ARiCO20 PAGE 4
	100ARG30 PAGE 6		100ARi40MTL PAGE 4	



TR Standard Range

65mm	65TRG25 PAGE 22	65TRi25 PAGE 22	65TRi25MTL PAGE 21	65TRiCO25 PAGE 21
	65TRG40 PAGE 24	65TRi40 PAGE 23	65TRi40MTL PAGE 23	
100mm	100TRG20 PAGE 8	100TRi20 PAGE 8	100TRi20MTL PAGE 7	100TRiCO20 PAGE 7
			100TRi40MTL PAGE 7	

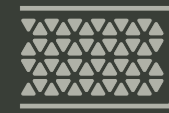

MND Marc Newson Design

65mm	65MNDG25 PAGE 31	65MNDi25 PAGE 30	65MNDi25MTL PAGE 29	65MNDiCO25 PAGE 29
	65MNDGP25 PAGE 32	65MNDiP25 PAGE 31	65MNDiP25MTL PAGE 29	65MNDiCOP25 PAGE 30
100mm	100MNDG20 PAGE 13	100MNDi20 PAGE 12	100MNDi20MTL PAGE 11	100MNDiCO20 PAGE 11
			100MNDiP20MTL PAGE 11	100MNDiCOP20 PAGE 12



PS Punched Slot

RANGE - WIDTH -	MODULAR KITS		MADE TO LENGTH - CUSTOM OUTLET -	FIXED-LENGTH - CENTRE OUTLET -
	uPVC Channel	Stainless Steel Channel	All Stainless Steel	All Stainless Steel
38mm	38PSG40 PAGE 42		38PSi40MTL PAGE 42	
65mm	65PSG25 PAGE 34	65PSi25 PAGE 34	65PSi25MTL PAGE 33	65PSiCO25 PAGE 33
	65PSG40 PAGE 36	65PSi40 PAGE 35	65PSi40MTL PAGE 35	
100mm	100PSG20 PAGE 16	100PSi20 PAGE 16		100PSiCO20 PAGE 15

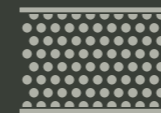

PH Punched Hole

38mm	38PHG40 PAGE 43		38PHi40MTL PAGE 43	
65mm	65PHG25 PAGE 38	65PHi25 PAGE 38	65PHi25MTL PAGE 37	65PHiCO25 PAGE 37
	65PHG40 PAGE 40	65PHi40 PAGE 39	65PHi40MTL PAGE 39	



Ti Tile Insert

65mm	65TiG40 PAGE 26	65Tii40 PAGE 26	65Tii30MTL PAGE 25	65TiiCO30 PAGE 25
			65Tii40MTL PAGE 25	
100mm			100Tii30MTL PAGE 9	100TiiCO30 PAGE 9
			100Tii40MTL PAGE 9	



TRTi Standard Range Tile Insert

65mm	65TRTiG25 PAGE 28	65TRTi25 PAGE 28	65TRTi25MTL PAGE 27	65TRTiCO25 PAGE 27
100mm			100TRTi25MTL PAGE 10	100TRTiCO25 PAGE 10

Product Codes

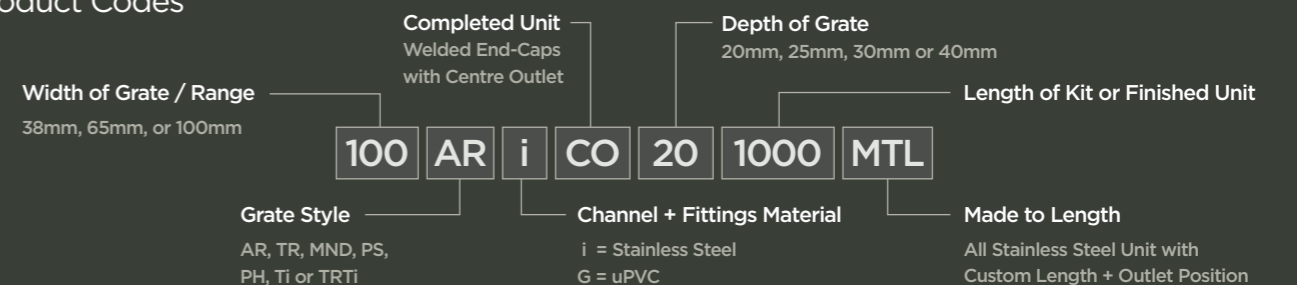

100 Range

Available Grate Styles

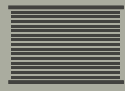

AR



TR

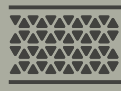

MND



PS



Ti



TRTi

100AR

The 100AR is the original premium architectural grate featuring a 2mm wire/2.5mm gap.

Manufactured from 316 marine grade stainless steel, the 100AR is 100mm wide and available in 20mm depth as Modular or Fixed-Length Units. Made-to-Length available in 20mm and 40mm depths.

316
GRADE



Made-to-Length

All stainless steel drainage unit made to specified length with specified outlet position.

Outlet Suits Pipe: DN40 / DN50 / DN65 / DN80 / DN100

PRODUCT	WIDTH x DEPTH
100ARi20MTL	109mm x 22mm
100ARi40MTL	109mm x 42mm

Fixed-Length Units

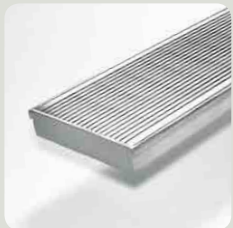

100ARiCO20

All Stainless Steel
Outlet Suits Pipe: DN80

FIXED-LENGTH UNIT

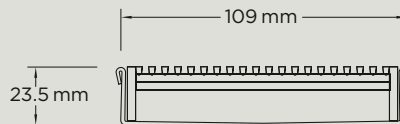

PRODUCT	LENGTH
100ARiCO20-0900	900mm
100ARiCO20-1000	1000mm

PRODUCT	LENGTH
100ARiCO20-1200	1200mm
100ARiCO20-1500	1500mm

Modular Kits

Lengths over 3000mm available on request.

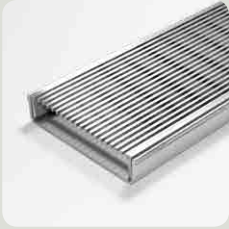

100ARi20

All Stainless Steel

Outlet Suits Pipe: DN50 / DN80

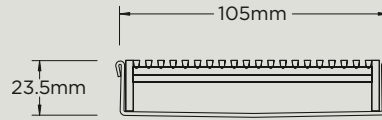

MODULAR KIT

PRODUCT	LENGTH - UP TO -
100ARi20-0900	900mm
100ARi20-1000	1000mm
100ARi20-1200	1200mm
100ARi20-1500	1500mm
100ARi20-1800	1800mm
100ARi20-1900	1900mm
100ARi20-2000	2000mm
100ARi20-2100	2100mm

PRODUCT	LENGTH - UP TO -
100ARi20-2200	2200mm
100ARi20-2400	2400mm
100ARi20-2500	2500mm
100ARi20-2700	2700mm
100ARi20-2800	2800mm
100ARi20-2900	2900mm
100ARi20-3000	3000mm

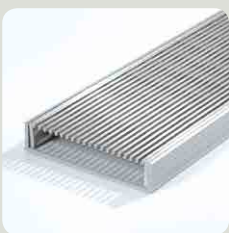

100ARG20

uPVC Channel + Fittings

Outlet Suits Pipe: DN40 / DN50 / DN80 / DN100

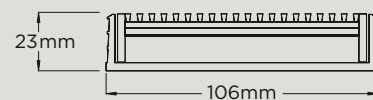

MODULAR KIT

PRODUCT	LENGTH - UP TO -
100ARG20-0900	900mm
100ARG20-1000	1000mm
100ARG20-1200	1200mm
100ARG20-1500	1500mm
100ARG20-1800	1800mm
100ARG20-1900	1900mm
100ARG20-2000	2000mm
100ARG20-2100	2100mm

PRODUCT	LENGTH - UP TO -
100ARG20-2200	2200mm
100ARG20-2400	2400mm
100ARG20-2500	2500mm
100ARG20-2700	2700mm
100ARG20-2800	2800mm
100ARG20-2900	2900mm
100ARG20-3000	3000mm

100 Range



100ARG30

uPVC Channel + Fittings

Outlet Suits Pipe: DN40 / DN50 / DN80 / DN100

MODULAR KIT

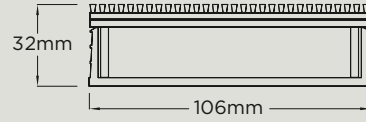

PRODUCT	LENGTH - UP TO -
100ARG30-0900	900mm
100ARG30-1000	1000mm
100ARG30-1200	1200mm
100ARG30-1500	1500mm
100ARG30-1800	1800mm
100ARG30-1900	1900mm
100ARG30-2000	2000mm
100ARG30-2100	2100mm

PRODUCT	LENGTH - UP TO -
100ARG30-2200	2200mm
100ARG30-2400	2400mm
100ARG30-2500	2500mm
100ARG30-2700	2700mm
100ARG30-2800	2800mm
100ARG30-2900	2900mm
100ARG30-3000	3000mm

100 Range



The 100TR is a standard style grate featuring a 3mm wire/5mm gap.

Manufactured from 316 marine grade stainless steel, the 100TR is 100mm wide and available in 20mm depth as Modular or Fixed-Length Units, and 40mm or 20mm as Made-to-Length.



Made-to-Length

All stainless steel drainage unit made to specified length with specified outlet position.

Outlet Suits Pipe: DN40 / DN50 / DN65 / DN80 / DN100

Note: 304 grade stainless steel available on application.

PRODUCT	WIDTH x DEPTH
100TRi20MTL	109mm x 22mm
100TRi40MTL	109mm x 42mm

Fixed-Length Units



100TRiCO20

All Stainless Steel

Outlet Suits Pipe: DN80

FIXED-LENGTH UNIT

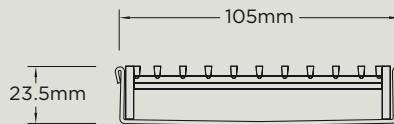

PRODUCT	LENGTH
100TRiCO20-0900	900mm
100TRiCO20-1000	1000mm

PRODUCT	LENGTH
100TRiCO20-1200	1200mm
100TRiCO20-1500	2200mm

100 Range

Modular Kits

Lengths over 3000mm available on request.



100TRI20

All Stainless Steel

Outlet Suits Pipe: DN50 / DN80

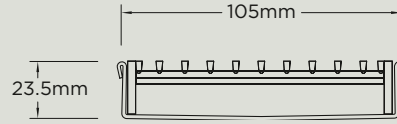

MODULAR KIT

PRODUCT	LENGTH - UP TO -
100TRI20-0900	900mm
100TRI20-1000	1000mm
100TRI20-1200	1200mm
100TRI20-1500	1500mm
100TRI20-1800	1800mm
100TRI20-1900	1900mm
100TRI20-2000	2000mm
100TRI20-2100	2100mm

PRODUCT	LENGTH - UP TO -
100TRI20-2200	2200mm
100TRI20-2400	2400mm
100TRI20-2500	2500mm
100TRI20-2700	2700mm
100TRI20-2800	2800mm
100TRI20-2900	2900mm
100TRI20-3000	3000mm



100TRG20

uPVC Channel + Fittings

Outlet Suits Pipe: DN40 / DN50 / DN80 / DN100

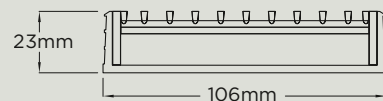

MODULAR KIT

PRODUCT	LENGTH - UP TO -
100TRG20-0900	900mm
100TRG20-1000	1000mm
100TRG20-1200	1200mm
100TRG20-1500	1500mm
100TRG20-1800	1800mm
100TRG20-1900	1900mm
100TRG20-2000	2000mm
100TRG20-2100	2100mm

PRODUCT	LENGTH - UP TO -
100TRG20-2200	2200mm
100TRG20-2400	2400mm
100TRG20-2500	2500mm
100TRG20-2700	2700mm
100TRG20-2800	2800mm
100TRG20-2900	2900mm
100TRG20-3000	3000mm

100 Range



The 100Ti is a premium Tile Insert drain designed to blend seamlessly with tiled floors.

Our premium Tile Insert is manufactured from 3mm stainless steel.

The 100Tii30MTL and 100TiiCO30 are suitable for tiles up to 12mm deep. The 100Tii40MTL is suitable for tiles up to 16mm deep.



Made-to-Length

All stainless steel drainage unit made to specified length with specified outlet position.

Outlet Suits Pipe: DN40 / DN50 / DN65 / DN80 / DN100

PRODUCT	WIDTH x DEPTH
100Tii30MTL	107mm x 33mm
100Tii40MTL	107mm x 42mm

Fixed-Length Units



100TiiCO30

All Stainless Steel
Outlet Suits Pipe: DN80

FIXED-LENGTH UNIT

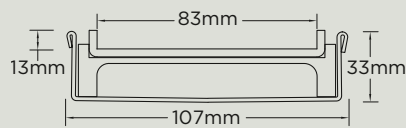

PRODUCT	LENGTH
100TiiCO30-0900	900mm
100TiiCO30-1000	1000mm

PRODUCT	LENGTH
100TiiCO30-1200	1200mm

100 Range

100TRTi

The 100TRTi is a standard Tile Insert drain designed to blend seamlessly with tiled floors.

Our standard Tile Insert is made from 1.5mm stainless steel.

The TRTi is suitable for a tile up to 8mm deep.

316
GRADE

Made-to-Length

All stainless steel drainage unit made to specified length with specified outlet position.

Outlet Suits Pipe: DN40 / DN50 / DN65 / DN80 / DN100

Note: 304 grade stainless steel available on application.

PRODUCT

WIDTH x DEPTH

100TRTi25MTL

107mm x 27mm

Fixed-Length Units



100TRTiCO25

All Stainless Steel

Outlet Suits Pipe: DN80

FIXED-LENGTH UNIT

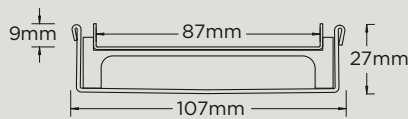

PRODUCT

LENGTH

100TRTiCO25-0900

900mm

100TRTiCO25-1000

1000mm

PRODUCT

LENGTH

100TRTiCO25-1200

1200mm



Our designer grate featuring a tessellated hexagonal design created in collaboration with Marc Newson.

5 FINISHES

316 GRADE

Finishes: Stainless Steel, Black, White, Brass, Blue

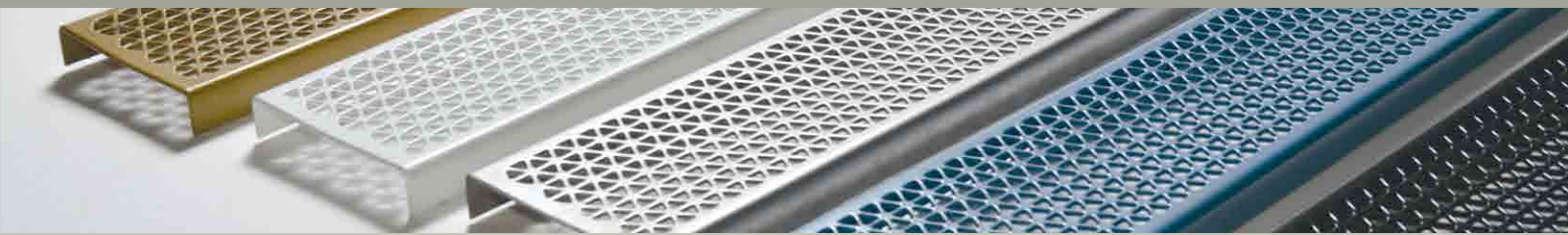
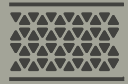

Made-to-Length

All stainless steel unit made to specified length with specified outlet position.

Outlet Suits Pipe:

DN40 / DN50 / DN65 / DN80 / DN100

PRODUCT	COLOUR	WIDTH x DEPTH
100MNDi20MTL	Stainless Steel	109mm x 22mm
100MNDiP20MTL	Black, White, Blue or Brass	109mm x 22mm

Fixed-Length Kits



100MNDiCO20

All Stainless Steel

Colour: Stainless Steel

Outlet Suits Pipe: DN80

FIXED-LENGTH UNIT

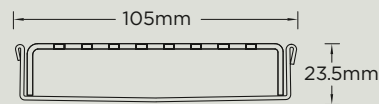

PRODUCT	LENGTH
100MNDiCO20-0900	900mm
100MNDiCO20-1000	1000mm

PRODUCT	LENGTH
100MNDiCO20-1200	1200mm
100MNDiCO20-1500	1500mm

100 Range



100MNDiCOP20

All Stainless Steel

Colour: Black / White / Blue / Brass

Outlet Suits Pipe: DN80

FIXED-LENGTH UNIT

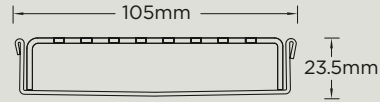

PLEASE SPECIFY COLOUR WITH ORDER

PRODUCT	LENGTH
100MNDiCOP20-0900	900mm
100MNDiCOP20-1000	1000mm

PRODUCT	LENGTH
100MNDiCOP20-1200	1200mm
100MNDiCOP20-1500	1500mm

Modular Kits

Lengths over 3000mm available on request.



100MNDi20

All Stainless Steel

Colour: Stainless Steel

Outlet Suits Pipe: DN50 / DN80

MODULAR KIT

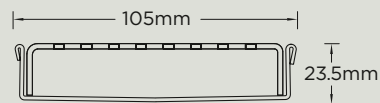

PRODUCT	LENGTH - UP TO -
100MNDi20-0900	900mm
100MNDi20-1000	1000mm
100MNDi20-1200	1200mm
100MNDi20-1500	1500mm
100MNDi20-1800	1800mm
100MNDi20-1900	1900mm
100MNDi20-2000	2000mm
100MNDi20-2100	2100mm

PRODUCT	LENGTH - UP TO -
100MNDi20-2200	2200mm
100MNDi20-2400	2400mm
100MNDi20-2500	2500mm
100MNDi20-2700	2700mm
100MNDi20-2800	2800mm
100MNDi20-2900	2900mm
100MNDi20-3000	3000mm

100 Range



100MNDG20

uPVC Channel + Fittings

Colour: Stainless Steel

Outlet Suits Pipe: DN40 / DN50 / DN80 / DN100

MODULAR KIT

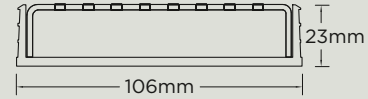

PRODUCT	LENGTH - UP TO -
100MNDG20-0900	900mm
100MNDG20-1000	1000mm
100MNDG20-1200	1200mm
100MNDG20-1500	1500mm
100MNDG20-1800	1800mm
100MNDG20-1900	1900mm
100MNDG20-2000	2000mm
100MNDG20-2100	2100mm

PRODUCT	LENGTH - UP TO -
100MNDG20-2200	2200mm
100MNDG20-2400	2400mm
100MNDG20-2500	2500mm
100MNDG20-2700	2700mm
100MNDG20-2800	2800mm
100MNDG20-2900	2900mm
100MNDG20-3000	3000mm



100MNDiP20

All Stainless Steel

Colour: Black / White / Blue / Brass

Outlet Suits Pipe: DN50 / DN80

MODULAR KIT

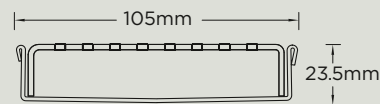

PLEASE SPECIFY COLOUR WITH ORDER

PRODUCT	LENGTH - UP TO -
100MNDiP20-0900	900mm
100MNDiP20-1000	1000mm
100MNDiP20-1200	1200mm
100MNDiP20-1500	1500mm
100MNDiP20-1800	1800mm
100MNDiP20-1900	1900mm
100MNDiP20-2000	2000mm
100MNDiP20-2100	2100mm

PRODUCT	LENGTH - UP TO -
100MNDiP20-2200	2200mm
100MNDiP20-2400	2400mm
100MNDiP20-2500	2500mm
100MNDiP20-2700	2700mm
100MNDiP20-2800	2800mm
100MNDiP20-2900	2900mm
100MNDiP20-3000	3000mm

100 Range

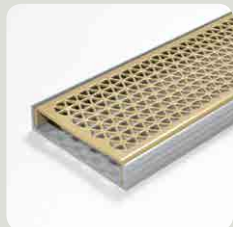

100MNDGP20

uPVC Channel + Fittings

Colour: Black / White / Blue / Brass

Outlet Suits Pipe: DN40 / DN50 / DN80 / DN100

MODULAR KIT

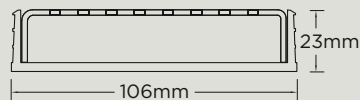

PLEASE SPECIFY COLOUR WITH ORDER

PRODUCT	LENGTH - UP TO -
100MNDGP20-0900	900mm
100MNDGP20-1000	1000mm
100MNDGP20-1200	1200mm
100MNDGP20-1500	1500mm
100MNDGP20-1800	1800mm
100MNDGP20-1900	1900mm
100MNDGP20-2000	2000mm
100MNDGP20-2100	2100mm

PRODUCT	LENGTH - UP TO -
100MNDGP20-2200	2200mm
100MNDGP20-2400	2400mm
100MNDGP20-2500	2500mm
100MNDGP20-2700	2700mm
100MNDGP20-2800	2800mm
100MNDGP20-2900	2900mm
100MNDGP20-3000	3000mm



The 100PS is a Punched Slot grate design.

Manufactured from 316 marine grade stainless steel, the 100PS is 100mm wide and available in 20mm depth as Modular Kits or Fixed-Length Units, and 40mm and 20mm as Made-to-Length.



Made-to-Length

All stainless steel drainage unit made to specified length with specified outlet position.

Outlet Suits Pipe: DN40 / DN50 / DN65 / DN80 / DN100

PRODUCT	WIDTH x DEPTH
100PSi20MTL	109mm x 22mm
100PSi40MTL	109mm x 42mm

Fixed-Length Units



100PSiCO20

All Stainless Steel
Outlet Suits Pipe: DN80

FIXED-LENGTH UNIT

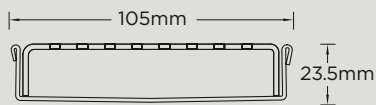

PRODUCT	LENGTH
100PSiCO20-0900	900mm
100PSiCO20-1000	1000mm

PRODUCT	LENGTH
100PSiCO20-1200	1200mm
100PSiCO20-1500	1500mm

100 Range

Modular Kits

Lengths over 3000mm available on request.



100PSi20

All Stainless Steel

Outlet Suits Pipe: DN50 / DN80

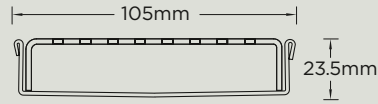

MODULAR KIT

PRODUCT	LENGTH - UP TO -
100PSi20-0900	900mm
100PSi20-1000	1000mm
100PSi20-1200	1200mm
100PSi20-1500	1500mm
100PSi20-1800	1800mm
100PSi20-1900	1900mm
100PSi20-2000	2000mm
100PSi20-2100	2100mm

PRODUCT	LENGTH - UP TO -
100PSi20-2200	2200mm
100PSi20-2400	2400mm
100PSi20-2500	2500mm
100PSi20-2700	2700mm
100PSi20-2800	2800mm
100PSi20-2900	2900mm
100PSi20-3000	3000mm

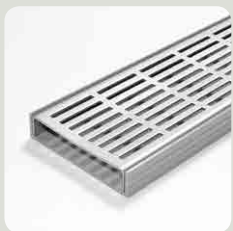

100PSG20

uPVC Channel + Fittings

Outlet Suits Pipe: DN40 / DN50 / DN80 / DN100

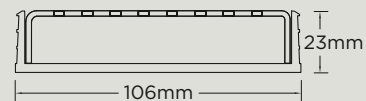

MODULAR KIT

PRODUCT	LENGTH - UP TO -
100PSG20-0900	900mm
100PSG20-1000	1000mm
100PSG20-1200	1200mm
100PSG20-1500	1500mm
100PSG20-1800	1800mm
100PSG20-1900	1900mm
100PSG20-2000	2000mm
100PSG20-2100	2100mm

PRODUCT	LENGTH - UP TO -
100PSG20-2200	2200mm
100PSG20-2400	2400mm
100PSG20-2500	2500mm
100PSG20-2700	2700mm
100PSG20-2800	2800mm
100PSG20-2900	2900mm
100PSG20-3000	3000mm

65 Range

Available Grate Styles



AR



TR

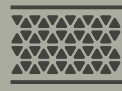

MND



PS



Ti



TRTi

65AR25

The 65AR25 is our original premium architectural grate and features a 2mm wire/2.5mm gap.

Manufactured from 316 marine grade the 65AR25 is 65mm wide and 25mm deep.

316
GRADE



Made-to-Length

All stainless steel drainage unit made to specified length with specified outlet position.

Outlet Suits Pipe: DN40 / DN50 / DN65

PRODUCT	WIDTH x DEPTH
65ARi25MTL	74mm x 27mm

Fixed-Length Units



65ARiCO25

All Stainless Steel

Outlet Suits Pipe: DN50

FIXED-LENGTH UNIT

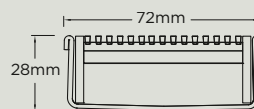

PRODUCT	LENGTH
65ARiCO25-0900	900mm
65ARiCO25-1000	1000mm

PRODUCT	LENGTH
65ARiCO25-1200	1200mm
65ARiCO25-1500	1500mm

65 Range

Modular Kits

Lengths over 3000mm available on request.



65ARi25

All Stainless Steel
Outlet Suits Pipe: DN50

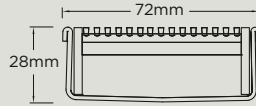

MODULAR KIT

PRODUCT	LENGTH - UP TO -
65ARi25-0750	750mm
65ARi25-0900	900mm
65ARi25-1000	1000mm
65ARi25-1200	1200mm
65ARi25-1500	1500mm
65ARi25-1800	1800mm
65ARi25-1900	1900mm
65ARi25-2000	2000mm

PRODUCT	LENGTH - UP TO -
65ARi25-2100	2100mm
65ARi25-2200	2200mm
65ARi25-2400	2400mm
65ARi25-2500	2500mm
65ARi25-2700	2700mm
65ARi25-2800	2800mm
65ARi25-2900	2900mm
65ARi25-3000	3000mm



65ARG25

uPVC Channel + Fittings
Outlet Suits Pipe: DN40 / DN50

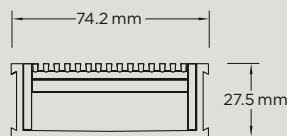

MODULAR KIT

PRODUCT	LENGTH - UP TO -
65ARG25-0750	750mm
65ARG25-0900	900mm
65ARG25-1000	1000mm
65ARG25-1200	1200mm
65ARG25-1500	1500mm
65ARG25-1800	1800mm
65ARG25-1900	1900mm
65ARG25-2000	2000mm

PRODUCT	LENGTH - UP TO -
65ARG25-2100	2100mm
65ARG25-2200	2200mm
65ARG25-2400	2400mm
65ARG25-2500	2500mm
65ARG25-2700	2700mm
65ARG25-2800	2800mm
65ARG25-2900	2900mm
65ARG25-3000	3000mm

65AR40

The 65AR40 is our original premium style architectural grate design and features a 2mm wire/2.5mm gap.

Manufactured from 316 marine grade the 65AR40 is 65mm wide and 40mm deep.

316
GRADE



Made-to-Length

All stainless steel drainage unit made to specified length with specified outlet position.

Outlet Suits Pipe: DN40 / DN50 / DN65

PRODUCT

WIDTH x DEPTH

65ARi40MTL

74mm x 42mm

Modular Kits

Lengths over 3000mm available on request.



65ARi40

All Stainless Steel
Outlet Suits Pipe: DN50

MODULAR KIT

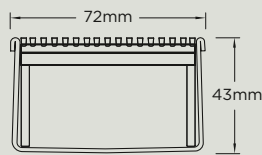

PRODUCT	LENGTH - UP TO -
65ARi40-0900	900mm
65ARi40-1000	1000mm
65ARi40-1200	1200mm
65ARi40-1500	1500mm
65ARi40-1800	1800mm
65ARi40-1900	1900mm
65ARi40-2000	2000mm
65ARi40-2100	2100mm

PRODUCT	LENGTH - UP TO -
65ARi40-2200	2200mm
65ARi40-2400	2400mm
65ARi40-2500	2500mm
65ARi40-2700	2700mm
65ARi40-2800	2800mm
65ARi40-2900	2900mm
65ARi40-3000	3000mm

65 Range



65ARG40

uPVC Channel + Fittings

Outlet Suits Pipe: DN40 / DN50

MODULAR KIT

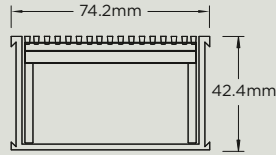

PRODUCT	LENGTH - UP TO -
65ARG40-0900	900mm
65ARG40-1000	1000mm
65ARG40-1200	1200mm
65ARG40-1500	1500mm
65ARG40-1800	1800mm
65ARG40-1900	1900mm
65ARG40-2000	2000mm
65ARG40-2100	2100mm

PRODUCT	LENGTH - UP TO -
65ARG40-2200	2200mm
65ARG40-2400	2400mm
65ARG40-2500	2500mm
65ARG40-2700	2700mm
65ARG40-2800	2800mm
65ARG40-2900	2900mm
65ARG40-3000	3000mm

65 Range

Available Grate Styles



AR



TR



Ti



TRTi

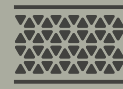

MND



PS

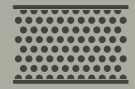

PH

65TR25

The 65TR25 is a standard grate design featuring a 3mm wire/5mm gap.

Manufactured from 316 marine grade the 65TR25 is 65mm wide and 25mm deep.



Made-to-Length

All stainless steel drainage unit made to specified length with specified outlet position.

Outlet Suits Pipe: DN40 / DN50 / DN65

Note: 304 grade stainless steel available on application.

PRODUCT	WIDTH x DEPTH
65TRi25MTL	74mm x 27mm

Fixed-Length Units



65TRiCO25

All Stainless Steel

Outlet Suits Pipe: DN50

FIXED-LENGTH UNIT

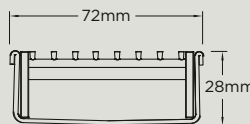

PRODUCT	LENGTH
65TRiCO25-0900	900mm
65TRiCO25-1000	1000mm

PRODUCT	LENGTH
65TRiCO25-1200	1200mm
65TRiCO25-1500	1500mm

65 Range

Modular Kits

Lengths over 3000mm available on request.



65TRi25

All Stainless Steel
Outlet Suits Pipe: DN50

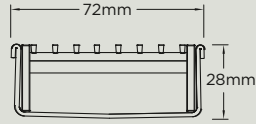

MODULAR KIT

PRODUCT	LENGTH - UP TO -
65TRi25-0900	900mm
65TRi25-1000	1000mm
65TRi25-1200	1200mm
65TRi25-1500	1500mm
65TRi25-1800	1800mm
65TRi25-1900	1900mm
65TRi25-2000	2000mm
65TRi25-2100	2100mm

PRODUCT	LENGTH - UP TO -
65TRi25-2200	2200mm
65TRi25-2400	2400mm
65TRi25-2500	2500mm
65TRi25-2700	2700mm
65TRi25-2800	2800mm
65TRi25-2900	2900mm
65TRi25-3000	3000mm

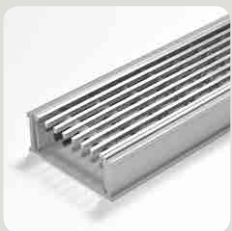

65TRG25

uPVC Channel + Fittings
Outlet Suits Pipe: DN40 / DN50

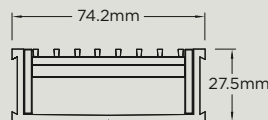

MODULAR KIT

PRODUCT	LENGTH - UP TO -
65TRG25-0900	900mm
65TRG25-1000	1000mm
65TRG25-1200	1200mm
65TRG25-1500	1500mm
65TRG25-1800	1800mm
65TRG25-1900	1900mm
65TRG25-2000	2000mm
65TRG25-2100	2100mm

PRODUCT	LENGTH - UP TO -
65TRG25-2200	2200mm
65TRG25-2400	2400mm
65TRG25-2500	2500mm
65TRG25-2700	2700mm
65TRG25-2800	2800mm
65TRG25-2900	2900mm
65TRG25-3000	3000mm



The 65TR40 is a standard style grate featuring a 3mm wire/5mm gap.

Manufactured from 316 marine grade the 65TR40 is 65mm wide and 40mm deep.



Made-to-Length

All stainless steel drainage unit made to specified length with specified outlet position.

Outlet Suits Pipe: DN40 / DN50 / DN65

PRODUCT	WIDTH x DEPTH
65TRi40MTL	74mm x 27mm

Modular Kits

Lengths over 3000mm available on request.

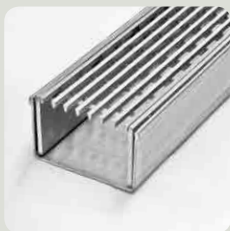

65TRi40

All Stainless Steel
Outlet Suits Pipe: DN50

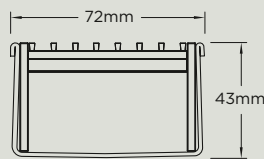

MODULAR KIT

PRODUCT	LENGTH - UP TO -
65TRi40-0900	900mm
65TRi40-1000	1000mm
65TRi40-1200	1200mm
65TRi40-1500	1500mm
65TRi40-1800	1800mm
65TRi40-1900	1900mm
65TRi40-2000	2000mm
65TRi40-2100	2100mm

PRODUCT	LENGTH - UP TO -
65TRi40-2200	2200mm
65TRi40-2400	2400mm
65TRi40-2500	2500mm
65TRi40-2700	2700mm
65TRi40-2800	2800mm
65TRi40-2900	2900mm
65TRi40-3000	3000mm

65 Range



65TRG40

uPVC Channel + Fittings
Outlet Suits Pipe: DN40 / DN50

MODULAR KIT

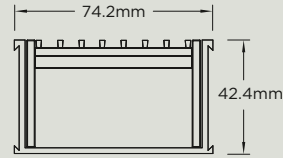

PRODUCT	LENGTH - UP TO -
65TRG40-0900	900mm
65TRG40-1000	1000mm
65TRG40-1200	1200mm
65TRG40-1500	1500mm
65TRG40-1800	1800mm
65TRG40-1900	1900mm
65TRG40-2000	2000mm
65TRG40-2100	2100mm

PRODUCT	LENGTH - UP TO -
65TRG40-2200	2200mm
65TRG40-2400	2400mm
65TRG40-2500	2500mm
65TRG40-2700	2700mm
65TRG40-2800	2800mm
65TRG40-2900	2900mm
65TRG40-3000	3000mm



The 65Ti is a premium tile insert drain that has been designed to blend in with a finished floor.

65Tii30MTL / 65TiiCO30 Suits tiles up to 12mm thick.

65Tii40MTL / 65TiG40 Suits tiles up to 16mm thick.

65Tii40 / 65TiG40 Suits tiles up to 20mm thick.



Made-to-Length

All stainless steel drainage unit made to specified length with specified outlet position.

Outlet Suits Pipe: DN40 / DN50 / DN65

PRODUCT	WIDTH x DEPTH
65Tii30MTL	74mm x 33mm
65Tii40MTL	74mm x 42mm

Fixed-Length Units



65TiiCO30

All Stainless Steel
Outlet Suits Pipe: DN50

FIXED-LENGTH UNIT

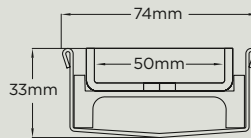

PRODUCT	LENGTH
65TiiCO30-0900	900mm
65TiiCO30-1000	1000mm

PRODUCT	LENGTH
65TiiCO30-1200	1200mm

65 Range

Modular Kits

Lengths over 3000mm available on request.



65Tii40

All Stainless Steel

Outlet Suits Pipe: DN50

MODULAR KIT

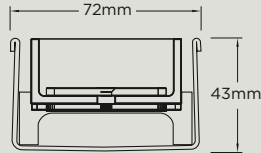

PRODUCT	LENGTH - UP TO -
65Tii40-1000	1000mm
65Tii40-1200	1200mm
65Tii40-2000	2000mm

PRODUCT	LENGTH - UP TO -
65Tii40-2200	2200mm
65Tii40-2400	2400mm
65Tii40-3000	3000mm



65TiG40

uPVC Channel + Fittings

Outlet Suits Pipe: DN40 / DN50

MODULAR KIT

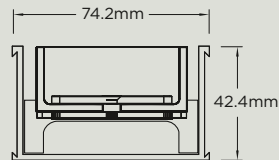

PRODUCT	LENGTH - UP TO -
65TiG40-1000	1000mm
65TiG40-1200	1200mm
65TiG40-2000	2000mm

PRODUCT	LENGTH - UP TO -
65TiG40-2200	2200mm
65TiG40-2400	2400mm
65TiG40-3000	3000mm

65TRTi

The 65TRTi is a standard Tile Insert drain designed to blend in with a tiled floor.

The standard tile insert is made from 1.5mm thick sheet. The 65TRTi series is suitable for up to a 8mm thick tile.

316
GRADE



Made-to-Length

All stainless steel drainage unit made to specified length with specified outlet position.

Outlet Suits Pipe: DN40 / DN50 / DN65

Note: 304 grade stainless steel available on application.

PRODUCT

WIDTH x DEPTH

65TRTi25MTL

74mm x 27mm

Fixed-Length Units



65TRTiCO25

All Stainless Steel

Outlet Suits Pipe: DN50

FIXED-LENGTH UNIT

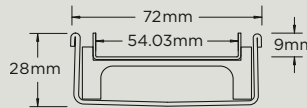

PRODUCT

LENGTH

65TRTiCO25-0900

900mm

65TRTiCO25-1000

1000mm

PRODUCT

LENGTH

65TRTiCO25-1200

1200mm

65 Range

Modular Kits



65TRTi25

All Stainless Steel
Outlet Suits Pipe: DN50

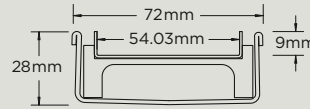

MODULAR KIT

PRODUCT	LENGTH
65TRTi25-0900	900mm
65TRTi25-1000	1000mm

PRODUCT	LENGTH
65TRTi25-1200	1200mm



65TRTiG25

uPVC Channel + Fittings
Outlet Suits Pipe: DN40 / DN50

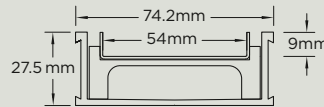

MODULAR KIT

PRODUCT	LENGTH
65TRTiG25-0900	900mm
65TRTiG25-1000	1000mm

PRODUCT	LENGTH
65TRTiG25-1200	1200mm



Our designer grate featuring a tessellated hexagonal design created by Marc Newson.

Manufactured from 316 marine grade stainless steel. 65mm wide and 25mm deep as Made-to-Length, Modular Kits & Fixed-Length Units. Finishes: Stainless Steel, Black, White, Brass, Blue

5 FINISHES

316 GRADE

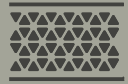

Made-to-Length

All stainless steel drainage unit made to specified length with specified outlet position.

Outlet Suits Pipe: DN40 / DN50 / DN65

PRODUCT	COLOUR	WIDTH x DEPTH
65MNDi25MTL	Stainless Steel	74mm x 27mm
65MNDiP25MTL	Black, White, Blue or Brass	74mm x 27mm

Fixed-Length Units



65MNDiCO25

All Stainless Steel
 Colour: Stainless Steel
 Outlet Suits Pipe: DN50

FIXED-LENGTH UNIT

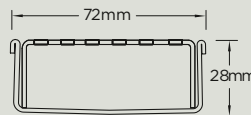

PRODUCT	LENGTH
65MNDiCO25-0900	900mm
65MNDiCO25-1000	1000mm

PRODUCT	LENGTH
65MNDiCO25-1200	1200mm
65MNDiCO25-1500	1500mm

65 Range



65MNDiCOP25

All Stainless Steel

Colour: Black / White / Blue / Brass

Outlet Suits Pipe: DN50

FIXED-LENGTH UNIT

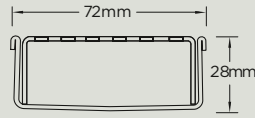

PLEASE SPECIFY COLOUR WITH ORDER

PRODUCT	LENGTH
65MNDiCOP25-0900	900mm
65MNDiCOP25-1000	1000mm

PRODUCT	LENGTH
65MNDiCOP25-1200	1200mm
65MNDiCOP25-1500	1500mm

Modular Kits

Lengths over 3000mm available on request.



65MNDi25

All Stainless Steel

Colour: Stainless Steel

Outlet Suits Pipe: DN50

MODULAR KIT

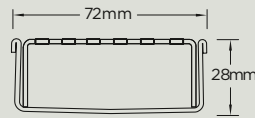

PRODUCT	LENGTH - UP TO -
65MNDi25-0900	900mm
65MNDi25-1000	1000mm
65MNDi25-1200	1200mm
65MNDi25-1500	1500mm
65MNDi25-1800	1800mm
65MNDi25-1900	1900mm
65MNDi25-2000	2000mm
65MNDi25-2100	2100mm

PRODUCT	LENGTH - UP TO -
65MNDi25-2200	2200mm
65MNDi25-2400	2400mm
65MNDi25-2500	2500mm
65MNDi25-2700	2700mm
65MNDi25-2800	2800mm
65MNDi25-2900	2900mm
65MNDi25-3000	3000mm

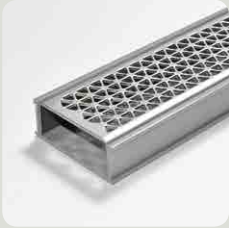

65MNDG25

uPVC Channel + Fittings
Colour: Stainless Steel
Outlet Suits Pipe: DN40 / DN50

MODULAR KIT

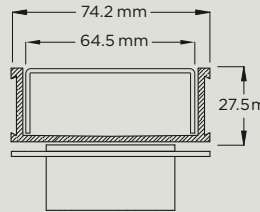

PRODUCT	LENGTH - UP TO -
65MNDG25-0900	900mm
65MNDG25-1000	1000mm
65MNDG25-1200	1200mm
65MNDG25-1500	1500mm
65MNDG25-1800	1800mm
65MNDG25-1900	1900mm
65MNDG25-2000	2000mm
65MNDG25-2100	2100mm

PRODUCT	LENGTH - UP TO -
65MNDG25-2200	2200mm
65MNDG25-2400	2400mm
65MNDG25-2500	2500mm
65MNDG25-2700	2700mm
65MNDG25-2800	2800mm
65MNDG25-2900	2900mm
65MNDG25-3000	3000mm

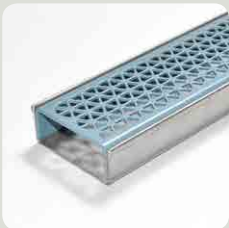

65MNDiP25

All Stainless Steel
Colour: Black / White / Blue / Brass
Outlet Suits Pipe: DN50

MODULAR KIT

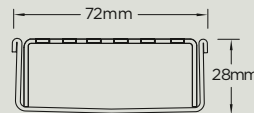

PLEASE
SPECIFY
COLOUR
WITH
ORDER

PRODUCT	LENGTH - UP TO -
65MNDiP25-0900	900mm
65MNDiP25-1000	1000mm
65MNDiP25-1200	1200mm
65MNDiP25-1500	1500mm
65MNDiP25-1800	1800mm
65MNDiP25-1900	1900mm
65MNDiP25-2000	2000mm
65MNDiP25-2100	2100mm

PRODUCT	LENGTH - UP TO -
65MNDiP25-2200	2200mm
65MNDiP25-2400	2400mm
65MNDiP25-2500	2500mm
65MNDiP25-2700	2700mm
65MNDiP25-2800	2800mm
65MNDiP25-2900	2900mm
65MNDiP25-3000	3000mm

65 Range

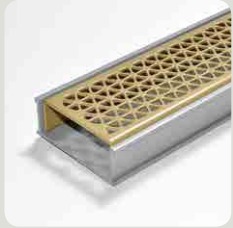

65MNDGP25

uPVC Channel + Fittings

Colour: Black / White / Blue / Brass

Outlet Suits Pipe: DN40 / DN50

MODULAR KIT

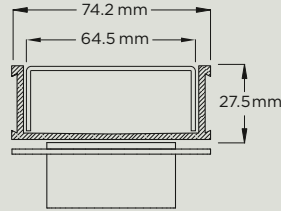

PLEASE
SPECIFY
COLOUR
WITH
ORDER

PRODUCT	LENGTH - UP TO -
65MNDGP25-0900	900mm
65MNDGP25-1000	1000mm
65MNDGP25-1200	1200mm
65MNDGP25-1500	1500mm
65MNDGP25-1800	1800mm
65MNDGP25-1900	1900mm
65MNDGP25-2000	2000mm
65MNDGP25-2100	2100mm

PRODUCT	LENGTH - UP TO -
65MNDGP25-2200	2200mm
65MNDGP25-2400	2400mm
65MNDGP25-2500	2500mm
65MNDGP25-2700	2700mm
65MNDGP25-2800	2800mm
65MNDGP25-2900	2900mm
65MNDGP25-3000	3000mm



The 65PS25 is a Punched Slot grate design.

Manufactured from 316 marine grade the 65PS25 is 65mm wide and 25mm deep.



Made-to-Length

All stainless steel drainage unit made to specified length with specified outlet position.

Outlet Suits Pipe: DN40 / DN50 / DN65

PRODUCT	WIDTH x DEPTH
65PSi25MTL	74mm x 27mm

Fixed-Length Units



65PSiCO25

All Stainless Steel
Outlet Suits Pipe: DN50

FIXED-LENGTH UNIT

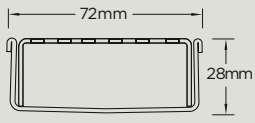

PRODUCT	LENGTH
65PSiCO25-0900	900mm
65PSiCO25-1000	1000mm

PRODUCT	LENGTH
65PSiCO25-1200	1200mm
65PSiCO25-1500	1500mm

65 Range

Modular Kits

Lengths over 3000mm available on request.



65PSi25

All Stainless Steel
Outlet Suits Pipe: DN50

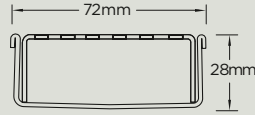

MODULAR KIT

PRODUCT	LENGTH - UP TO -
65PSi25-0900	900mm
65PSi25-1000	1000mm
65PSi25-1200	1200mm
65PSi25-1500	1500mm
65PSi25-1800	1800mm
65PSi25-1900	1900mm
65PSi25-2000	2000mm
65PSi25-2100	2100mm

PRODUCT	LENGTH - UP TO -
65PSi25-2200	2200mm
65PSi25-2400	2400mm
65PSi25-2500	2500mm
65PSi25-2700	2700mm
65PSi25-2800	2800mm
65PSi25-2900	2900mm
65PSi25-3000	3000mm



65PSG25

uPVC Channel + Fittings
Outlet Suits Pipe: DN40 / DN50

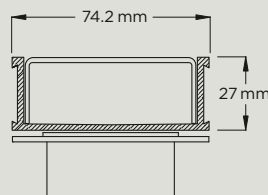

MODULAR KIT

PRODUCT	LENGTH - UP TO -
65PSG25-0900	900mm
65PSG25-1000	1000mm
65PSG25-1200	1200mm
65PSG25-1500	1500mm
65PSG25-1800	1800mm
65PSG25-1900	1900mm
65PSG25-2000	2000mm
65PSG25-2100	2100mm

PRODUCT	LENGTH - UP TO -
65PSG25-2200	2200mm
65PSG25-2400	2400mm
65PSG25-2500	2500mm
65PSG25-2700	2700mm
65PSG25-2800	2800mm
65PSG25-2900	2900mm
65PSG25-3000	3000mm

65PS40

The 65PS40 is a Punched Slot grate design.

Manufactured from 316 marine grade the 65PS40 is 65mm wide and 40mm deep.

**316
GRADE**



Made-to-Length

All stainless steel drainage unit made to specified length with specified outlet position.

Outlet Suits Pipe: DN40 / DN50 / DN65

PRODUCT

WIDTH x DEPTH

65PSi40MTL

74mm x 42mm

Modular Kits

Lengths over 3000mm available on request.



65PSi40

All Stainless Steel

Outlet Suits Pipe: DN50

MODULAR KIT

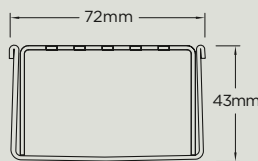

PRODUCT	LENGTH - UP TO -
65PSi40-0900	900mm
65PSi40-1000	1000mm
65PSi40-1200	1200mm
65PSi40-1500	1500mm
65PSi40-1800	1800mm
65PSi40-1900	1900mm
65PSi40-2000	2000mm
65PSi40-2100	2100mm

PRODUCT	LENGTH - UP TO -
65PSi40-2200	2200mm
65PSi40-2400	2400mm
65PSi40-2500	2500mm
65PSi40-2700	2700mm
65PSi40-2800	2800mm
65PSi40-2900	2900mm
65PSi40-3000	3000mm

65 Range



65PSG40

uPVC Channel + Fittings

Outlet Suits Pipe: DN40 / DN50

MODULAR KIT

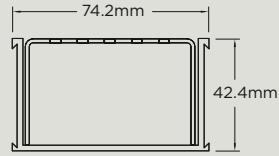

PRODUCT	LENGTH - UP TO -
65PSG40-0900	900mm
65PSG40-1000	1000mm
65PSG40-1200	1200mm
65PSG40-1500	1500mm
65PSG40-1800	1800mm
65PSG40-1900	1900mm
65PSG40-2000	2000mm
65PSG40-2100	2100mm

PRODUCT	LENGTH - UP TO -
65PSG40-2200	2200mm
65PSG40-2400	2400mm
65PSG40-2500	2500mm
65PSG40-2700	2700mm
65PSG40-2800	2800mm
65PSG40-2900	2900mm
65PSG40-3000	3000mm



The 65PH25 is a Punched Hole grate design.

Manufactured from 316 marine grade the 65PH25 is 65mm wide and 25mm deep.

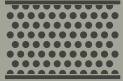

Made-to-Length

All stainless steel drainage unit made to specified length with specified outlet position.

Outlet Suits Pipe: DN40 / DN50 / DN65

PRODUCT	WIDTH x DEPTH
65PHi25MTL	74mm x 27mm

Fixed-Length Units



65PHiCO25

All Stainless Steel
Outlet Suits Pipe: DN50

FIXED-LENGTH UNIT

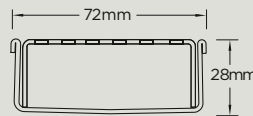

PRODUCT	LENGTH
65PHiCO25-0900	900mm
65PHiCO25-1000	1000mm

PRODUCT	LENGTH
65PHiCO25-1200	1200mm
65PHiCO25-1500	1500mm

65 Range

Modular Kits

Lengths over 3000mm available on request.



65PHi25

All Stainless Steel
Outlet Suits Pipe: DN50

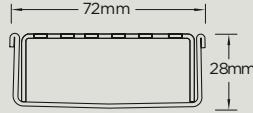

MODULAR KIT

PRODUCT	LENGTH - UP TO -
65PHi25-0900	900mm
65PHi25-1000	1000mm
65PHi25-1200	1200mm
65PHi25-1500	1500mm
65PHi25-1800	1800mm
65PHi25-1900	1900mm
65PHi25-2000	2000mm
65PHi25-2100	2100mm

PRODUCT	LENGTH - UP TO -
65PHi25-2200	2200mm
65PHi25-2400	2400mm
65PHi25-2500	2500mm
65PHi25-2700	2700mm
65PHi25-2800	2800mm
65PHi25-2900	2900mm
65PHi25-3000	3000mm



65PHG25

uPVC Channel + Fittings
Outlet Suits Pipe: DN40 / DN50

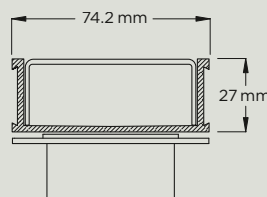

MODULAR KIT

PRODUCT	LENGTH - UP TO -
65PHG25-0900	900mm
65PHG25-1000	1000mm
65PHG25-1200	1200mm
65PHG25-1500	1500mm
65PHG25-1800	1800mm
65PHG25-1900	1900mm
65PHG25-2000	2000mm
65PHG25-2100	2100mm

PRODUCT	LENGTH - UP TO -
65PHG25-2200	2200mm
65PHG25-2400	2400mm
65PHG25-2500	2500mm
65PHG25-2700	2700mm
65PHG25-2800	2800mm
65PHG25-2900	2900mm
65PHG25-3000	3000mm



The 65PH40 is a Punched Hole grate design.

Manufactured from 316 marine grade the 65PH40 is 65mm wide and 40mm deep.

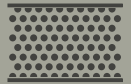

Made-to-Length

All stainless steel drainage unit made to specified length with specified outlet position.

Outlet Suits Pipe: DN40 / DN50 / DN65

PRODUCT	WIDTH x DEPTH
65PHi40MTL	74mm x 42mm

Modular Kits

Lengths over 3000mm available on request.



65PHi40

All Stainless Steel
Outlet Suits Pipe: DN50

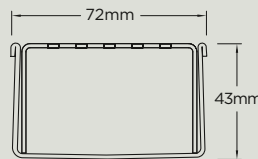

MODULAR KIT

PRODUCT	LENGTH - UP TO -
65PHi40-0900	900mm
65PHi40-1000	1000mm
65PHi40-1200	1200mm
65PHi40-1500	1500mm
65PHi40-1800	1800mm
65PHi40-1900	1900mm
65PHi40-2000	2000mm
65PHi40-2100	2100mm

PRODUCT	LENGTH - UP TO -
65PHi40-2200	2200mm
65PHi40-2400	2400mm
65PHi40-2500	2500mm
65PHi40-2700	2700mm
65PHi40-2800	2800mm
65PHi40-2900	2900mm
65PHi40-3000	3000mm

65 Range



65PHG40

uPVC Channel + Fittings
Outlet Suits Pipe: DN40 / DN50

MODULAR KIT

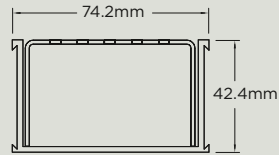

PRODUCT	LENGTH - UP TO -
65PHG40-0900	900mm
65PHG40-1000	1000mm
65PHG40-1200	1200mm
65PHG40-1500	1500mm
65PHG40-1800	1800mm
65PHG40-1900	1900mm
65PHG40-2000	2000mm
65PHG40-2100	2100mm

PRODUCT	LENGTH - UP TO -
65PHG40-2200	2200mm
65PHG40-2400	2400mm
65PHG40-2500	2500mm
65PHG40-2700	2700mm
65PHG40-2800	2800mm
65PHG40-2900	2900mm
65PHG40-3000	3000mm

38 Range

Available Grate Styles



AR



PS

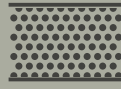

PH



The 38AR is a premium architectural grate design featuring a 2mm wire/2.5mm gap.

Manufactured from 316 marine grade the 38AR is 38mm wide and 40mm deep.



Made-to-Length

All stainless steel drainage unit made to specified length with specified outlet position.

Outlet Suits Pipe: DN40

PRODUCT	WIDTH x DEPTH
38ARi40MTL	43mm x 42mm

Modular Kits

Lengths over 3000mm available on request.



38ARG40

uPVC Channel + Fittings
Outlet Suits Pipe: DN40 / DN50

MODULAR KIT

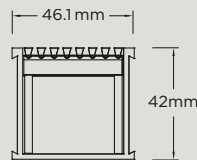

PRODUCT	LENGTH - UP TO -
38ARG40-1200	1200mm
38ARG40-1500	1500mm
38ARG40-2400	2400mm

PRODUCT	LENGTH - UP TO -
38ARG40-2700	2700mm
38ARG40-3000	3000mm

38 Range

38PS

The 38PS is a Punched Slot grate design.

Manufactured from 316 marine grade the 38PS is 38mm wide and 40mm deep.

316
GRADE



Made-to-Length

All stainless steel drainage unit made to specified length with specified outlet position.

Outlet Suits Pipe: DN40

PRODUCT

WIDTH x DEPTH

38PSi40MTL

43mm x 42mm

Modular Kits

Lengths over 3000mm available on request.



38PSG40

uPVC Channel + Fittings

Outlet Suits Pipe: DN40 / DN50

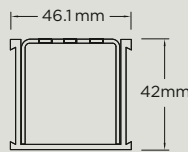

MODULAR KIT

PRODUCT	LENGTH - UP TO -
38PSG40-0900	900mm
38PSG40-1000	1000mm
38PSG40-1200	1200mm
38PSG40-1500	1500mm
38PSG40-1800	1800mm
38PSG40-1900	1900mm
38PSG40-2000	2000mm
38PSG40-2100	2100mm

PRODUCT	LENGTH - UP TO -
38PSG40-2200	2200mm
38PSG40-2400	2400mm
38PSG40-2500	2500mm
38PSG40-2700	2700mm
38PSG40-2800	2800mm
38PSG40-2900	2900mm
38PSG40-3000	3000mm

38PH

The 38PH is a Punched Hole grate design.

Manufactured from 316 marine grade the 38PH is 65mm wide and 40mm deep.

316
GRADE

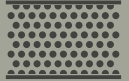

Made-to-Length

All stainless steel drainage unit made to specified length with specified outlet position.

Outlet Suits Pipe: DN40

PRODUCT

WIDTH x DEPTH

38PHi40MTL

43mm x 42mm

Modular Kits

Lengths over 3000mm available on request.



38PHG40

uPVC Channel + Fittings
Outlet Suits Pipe: DN40 / DN50

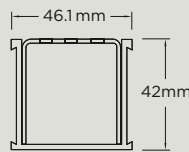

MODULAR KIT

PRODUCT	LENGTH - UP TO -
38PHG40-0900	900mm
38PHG40-1000	1000mm
38PHG40-1200	1200mm
38PHG40-1500	1500mm
38PHG40-1800	1800mm
38PHG40-1900	1900mm
38PHG40-2000	2000mm
38PHG40-2100	2100mm

PRODUCT	LENGTH - UP TO -
38PHG40-2200	2200mm
38PHG40-2400	2400mm
38PHG40-2500	2500mm
38PHG40-2700	2700mm
38PHG40-2800	2800mm
38PHG40-2900	2900mm
38PHG40-3000	3000mm

Square Range

Available
Grate Styles



AR



TR



Ti

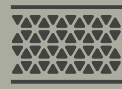

MND



PS

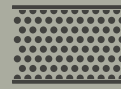

PH

SQ

Square drain units are manufactured from 316 marine grade stainless steel.

316
GRADE

The SQ Range of floor waste units allow the integration of a standard floor waste with Stormtech linear drainage.

Complete Square Units

SQ100



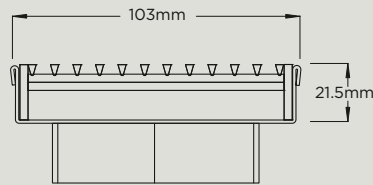

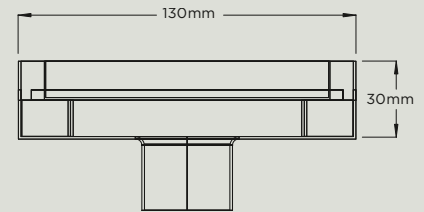

All Stainless Steel
76mm Outlet



SQ100AR



SQ100Ti

PRODUCT	ITEM DESCRIPTION	PRODUCT	ITEM DESCRIPTION
	103mm x 103mm 21.5mm Deep Architectural Grate		103mm x 103mm 21.5mm Deep Marc Newson Design Grate
	103mm x 103mm 21.5mm Deep Standard Grate		103mm x 103mm 21.5mm Deep Punched Slot Grate
	130mm x 130mm 30mm Deep Tile Insert		103mm x 103mm 21.5mm Deep Punched Hole Grate

Threshold Range

Available Grate Styles



AR



Ti



PS

TD

Featuring a linear stainless steel grate with concealed channel section connecting sill and sub-sill for door tracks and thresholds.

316
GRADE

Allows door sills to be drained while having internal and external floor surfaces with no step down.

Sill + Sub-Sill Usage

TDi

All Stainless Steel
Finished to Custom Length

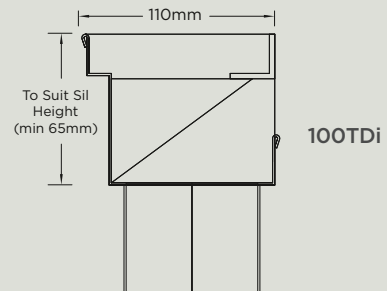
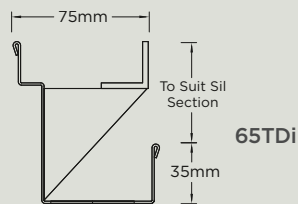

PRODUCT

ITEM DESCRIPTION



65ARTDi

65mm Wide
Architectural Grate

PRODUCT

ITEM DESCRIPTION



100ARTDi

100mm Wide
Architectural Grate



65TiTDi

65mm Wide
Tile Insert



100TiTDi

100mm Wide
Tile Insert



65PSTDi

65mm Wide
Punched Slot Grate



100PSTDi

100mm Wide
Punched Slot Grate





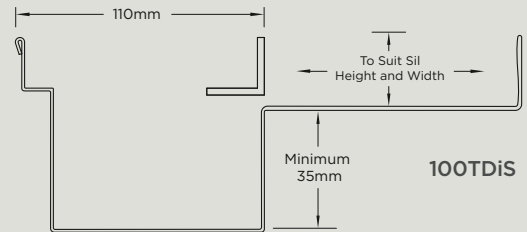
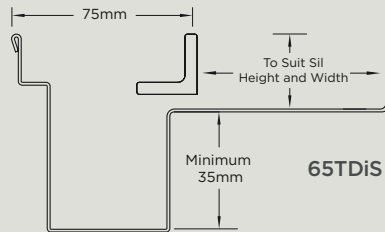

Threshold Range

Sill Only Usage

TDiS

All Stainless Steel
Finished to Custom Length



PRODUCT	ITEM DESCRIPTION	PRODUCT	ITEM DESCRIPTION
	65mm Wide Architectural Grate		100mm Wide Architectural Grate
	65mm Wide Tile Insert		100mm Wide Tile Insert
	65mm Wide Punched Slot Grate		100mm Wide Punched Slot Grate

Vinyl Clamp

Available Grate Styles



AR



Designed specifically for vinyl floor environments, the VC range of drain units are manufactured from 316 marine grade stainless steel.



Stainless steel vinyl clamp drainage unit for use in a vinyl floor environment.

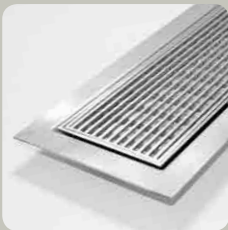

VC100-25

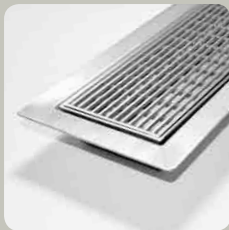

VC100-42



VC100-45

Vinyl Clamp Units

Custom length drainage unit with specified outlet position.

All Stainless Steel

PRODUCT	ITEM DESCRIPTION
VC100-25	Width: 170mm Depth: 25mm
VC100-42	Width: 170mm Depth: 42mm
VC100-45	Width: 155mm Depth: 45mm

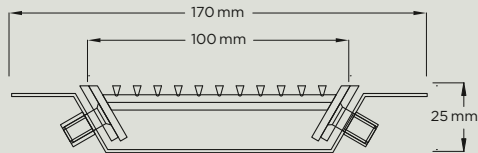

VC100-25

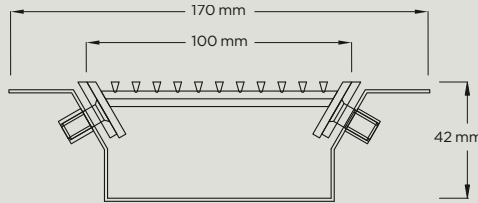

VC100-42

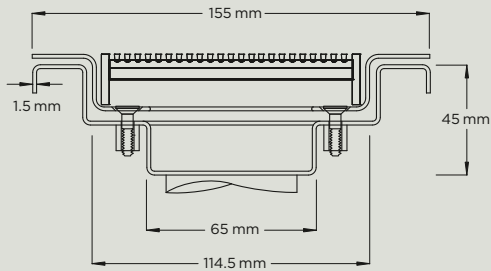

VC100-45

Special Assembly

Special Assembly

Developed for high capacity drainage needs, providing flexibility in landscape and pool design.

The Special Assembly Range features a drainage channel connected via downpipes at 200mm intervals to a drain pipe below.

65 Range Special Assembly



65G100 | 65G90

Add a 65mm grate from AR40, TR40, PS40 or PH40 to complete this system.

See Grates Below

PRODUCT	WIDTH x DEPTH
65G100	65mm wide channel and 100mm drain pipe assembly Length: 3000mm
65G90	65mm wide channel and 90mm drain pipe assembly Length: 3000mm

65AR40 GRATES Width: 65mm x Depth: 40mm



AR

PRODUCT	LENGTH	GRATE STYLE
65AR40-1000	1000mm	Architectural Grate
65AR40-1500	1500mm	Architectural Grate

65TR40 GRATES Width: 65mm x Depth: 40mm



TR

PRODUCT	LENGTH	GRATE STYLE
65TR40-1000	1000mm	Standard Grate
65TR40-1500	1500mm	Standard Grate

65PS40 GRATES Width: 65mm x Depth: 40mm



PS

PRODUCT	LENGTH	GRATE STYLE
65PS40-1000	1000mm	Punched Slot Grate
65PS40-1500	1500mm	Punched Slot Grate

65PH40 GRATES Width: 65mm x Depth: 40mm

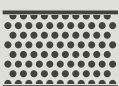

PH

PRODUCT	LENGTH	GRATE STYLE
65PH40-1000	1000mm	Punched Hole Grate
65PH40-1500	1500mm	Punched Hole Grate

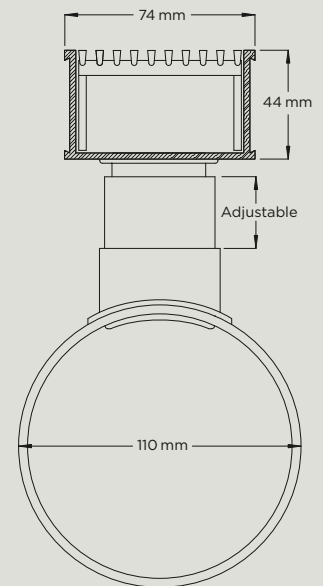

65G100

Special Assembly

38 Range Special Assembly



38G90 | 38G100

Add a 38mm grate from AR40, PS40 or PH40 to complete this system.

See Grates Below

PRODUCT	DESCRIPTION
38G90	38mm wide channel and 90mm drain pipe assembly Length: 3000mm
38G100	38mm wide channel and 100mm drain pipe assembly Length: 3000mm

38AR40 GRATES Width: 38mm x Depth: 40mm



AR

PRODUCT	LENGTH	GRATE STYLE
38AR40-1200	1200mm	Architectural Grate
38AR40-1500	1500mm	Architectural Grate

38PS40 GRATES Width: 38mm x Depth: 40mm



PS

PRODUCT	LENGTH	GRATE STYLE
38PS40-1000	1000mm	Punched Slot Grate
38PS40-1500	1500mm	Punched Slot Grate

38PH40 GRATES Width: 38mm x Depth: 40mm

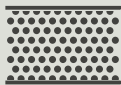

PH

PRODUCT	LENGTH	GRATE STYLE
38PH40-1000	1000mm	Punched Hole Grate
38PH40-1500	1500mm	Punched Hole Grate

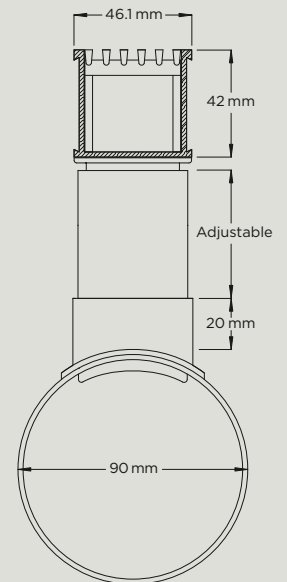

38G90

Slot Drain

Available
Grate Styles



AR

SD

The SD90 features a 25mm opening on the top with 20 slots draining into a concealed 90mm drain pipe.

The Slot Drain can be completed with a 30mm wide architectural wedge-wire grate as an optional item.

Slot Drain Components



Slot Drain

PRODUCT	ITEM DESCRIPTION
SD90	90mm Drain with UPVC Beige Insert (no holes) Length: 3000mm
SDi	Replacement Slot Drain Insert (no holes) Length: 3000mm
SDH	10mm Holes at 50mm centres Length: per 3000mm
SDJ	Slot Drain Joiner
SDiAR	Wedgewire Stainless Steel Grate 30mm Wide to Fit SD90 Length: Custom (per metre)

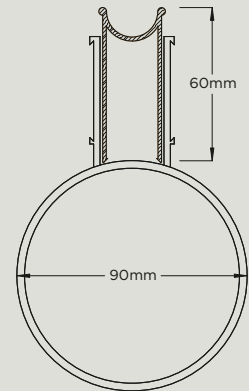

SD90

Custom Fabrication

Available Grate Styles



AR



TR



Ti

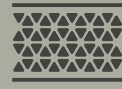

MND

Custom Made

For site specific needs or unusual situations, choose from our Custom Fabrication range.

Stormtech can customise any drainage requirements to achieve maximum efficiency.

316
GRADE

304
GRADE

Custom Items

PRODUCT	ITEM DESCRIPTION
50ARi	Up to 50mm wide drainage unit Depth: 20mm - 40mm
65ARi	51mm - 65mm wide drainage unit Depth: 20mm - 40mm
75ARi	66mm - 75mm wide drainage unit Depth: 20mm - 50mm
100ARi	76mm - 100mm wide drainage unit Depth: 20mm - 100mm
200ARi	101mm - 200mm wide drainage unit Depth: 20mm - 200mm
300ARi	201mm - 300mm wide drainage unit Depth: 20mm - 200mm
Custom	Fully Customised Drainage Unit: Width, Depth, Length, Outlet Size and Position
CFLB	Tiling Flange along length of the drainage channel
CFLE	Tiling Flange per end of the drainage channel
LED1000	LED strip complete with adaptor can be fitted to any grate.

Hydraulic Guide

Flow Rates

Refer to AS3500 for required outlet and pipe sizing appropriate to your application.

Please note this table is supplied as a guide only. For critical performance always consult a hydraulic engineer.

Hydraulic Table

Lateral flow rate is the flow rate along the channel towards the outlet or open end.

All flow rates specified for spigots are vertical flow rates.

CHANNEL	LATERAL FLOW RATE	DN40 SPIGOT	DN50 SPIGOT	DN80 SPIGOT	DN100 SPIGOT
38mm x 40mm	0.4 L/s	0.5 L/s	-	-	-
65mm x 40mm	0.7 L/s	0.5 L/s	1.0 L/s	-	-
65mm x 25mm	0.4 L/s	0.5 L/s	0.5 L/s	-	-
100mm x 20mm	0.4 L/s	0.5 L/s	0.5 L/s	0.5 L/s	0.5 L/s
100mm x 30mm	0.6 L/s	0.5 L/s	0.8 L/s	1.0 L/s	1.0 L/s
100mm x 40mm	0.9 L/s	0.5 L/s	1.0 L/s	1.0 L/s	1.1 L/s

Examples

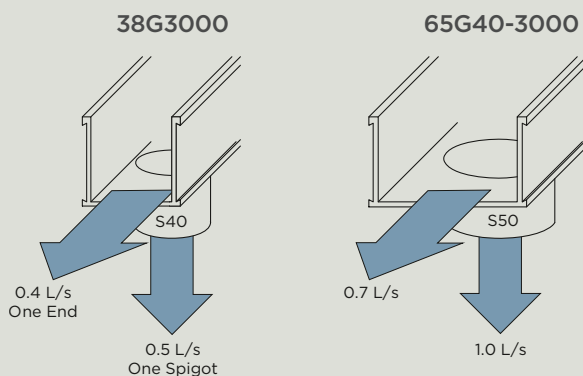

Stormtech Product Care

Stormtech stainless steel requires minimal attention and will not tarnish or corrode under normal circumstances.

Exposure to certain chemical or environmental conditions may, over time, promote surface oxidation. Please be aware this is not a defect in the stainless steel but a reaction on the surface of the finish to the chemical environment, which can be removed with a stainless steel polish.

Environmental Conditions

Individual sites and situations vary dramatically. Areas close to salt water, particularly breaking surf are severe corrosion environments. Particular care is required to maintain the stainless steel.

Visit **stormtech.com.au**
for detailed assembly
and installation information.

Technical Drawings

We provide complete CAD files
for download from our website.

Distributors + Stockists

To find a distributor near you, please visit our
website or call our office.

Stormtech Pty Ltd

Telephone 1300 653 403 | www.stormtech.com.au